

# SHAPE CATALOG

## Offset Shapes

PMC Software Inc.  
Suite 11 8 Bartles Corner Road  
Flemington, NJ 08822  
(908) 806-7824  
[www.pmcsoftware.com](http://www.pmcsoftware.com)

© 1986 PMC Software Inc.  
All Rights Reserved



## SHAPE CATALOG

---

The specifications, operational guidelines and other information contained in this document are subject to change without notice and should not be construed as a commitment by PMC Software or any of its support organizations. PMC and its support organizations assume no responsibility for any errors or omissions within this document, or from the use of the information obtained herein. Users are advised to insure that a current revision of this document is used at all times.

This software (and document) are both protected by U.S. copyright law (Title 17 U.S. Code). Unauthorized reproduction and/or sales may result in imprisonment of up to one year and fines of up to ten thousand dollars (17 USC 506). Copyright infringements may be subject to civil liabilities.

No part of this document may be reproduced, transmitted, transcribed, stored in any retrieval system, or translated into any language without the express written permission of PMC Software Inc.

## PREFACE

Computer controlled glass cutting tables offer the most advanced technology available for the fabrication of shapes. As your glass provider we've made a substantial investment to provide you with the highest dimensional accuracy as well as quality of scores by purchasing an automated table.

This machine has extreme flexibility but like all computers must be told exactly what to do. This catalog has been prepared to simplify the input of shape information. It illustrates exactly what is required when placing an order to eliminate the unnecessary forwarding of templates and other extraneous information, allowing us to service you even better.

# SHAPE CATALOG

Click a shape to view details.

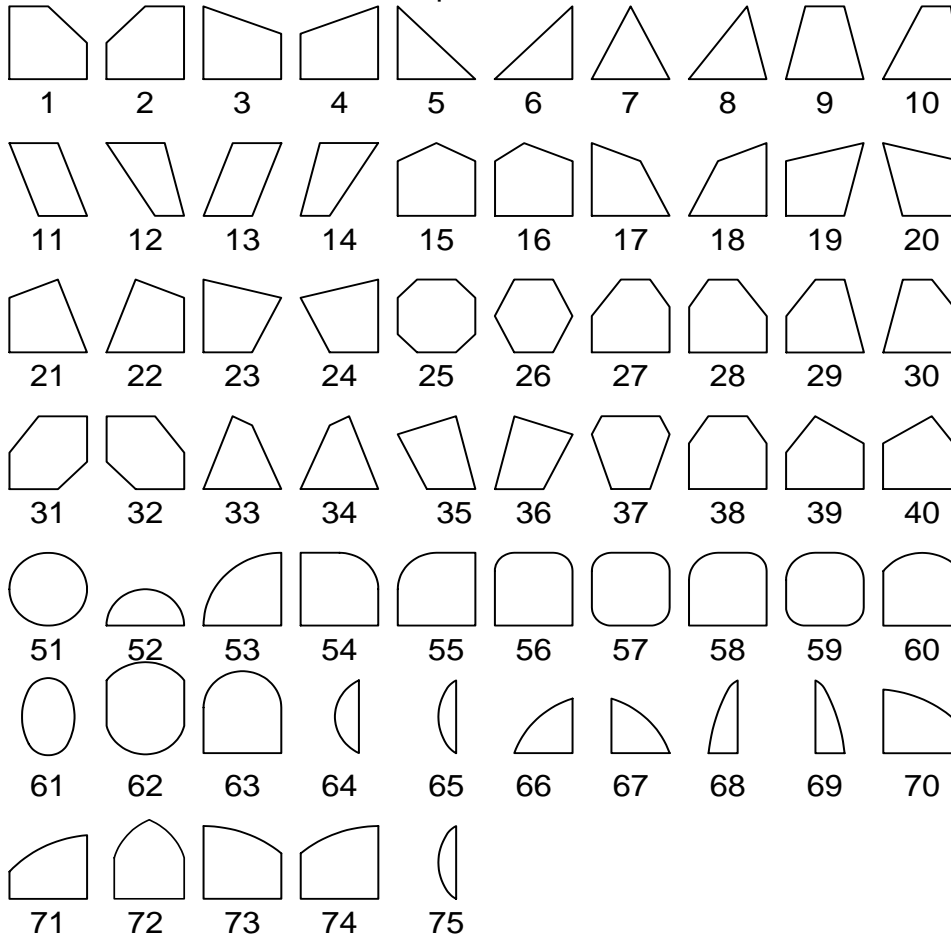

## OFFSET SHAPES

Click a shape to view details.



79



80



81



82



83



84



85



86



87



88



89



90



91



92



93



94



95



96



97



98

## CATALOG USAGE

A few simple steps need to be followed when using this catalog:

1. For each non-rectangular lite/unit ordered you will need to supply a shape number along with a set of dimensions.
2. Dimensions are specified in the Base, Left, Right, and Top technique used by most glaziers. (In some instances more than four dimensions are required to adequately define a shape. These dimensions have been given the highly original names of 'S1' and 'S2'.)
3. To insure accuracy, all measurements are taken perpendicular to the frame in which the glass will be glazed. The length of diagonal sides is never requested, but rather calculated based upon more easily obtainable dimensions.
4. The radius of a shape may not exceed 500 inches. Larger shapes may be drawn in another program, either CAD or digitized, and then imported.
5. All shapes are processed as if you were on the outside of a building looking in. Please take care when ordering coated glass to insure you've selected the shape that best matches your requirements.
6. If you don't find an immediate match of a shape number for the lite/unit you need, try to rotate your piece. Blue thumbnail figures under each shape will assist you in seeing the orientation potentials of each of our standard shapes.

## SHAPE CATALOG

---

7. Edgework side numbering appears on the outside perimeter of the shape for those shapes that permit edgework. Refer also to “Edgework Side Numbering” on page 52 for an overview of all shapes that may have edgework applied.
8. Red lower-case lettering marks the corners of a shape and may be used to indicate the positioning of logo(s) on the glass.

# NOTES



# SHAPE CATALOG

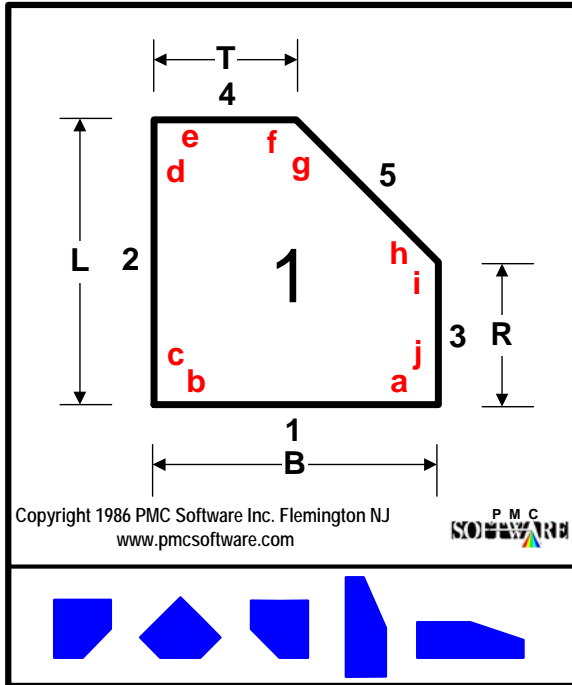

Copyright 1986 PMC Software Inc. Flemington NJ  
www.pmcsoftware.com



Base	Required
Left	Required
Right	Less Than Left
Top	Less Than Base
S1	
S2	
Edgework	Yes <a href="#">Click to view details.</a>

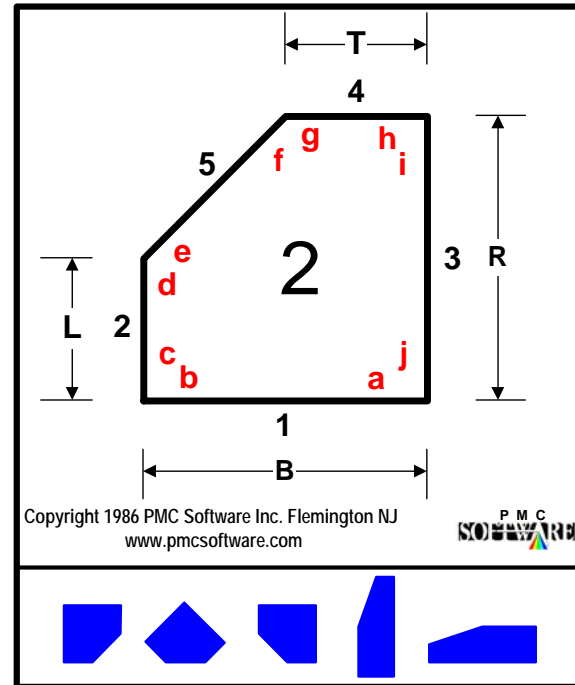

Copyright 1986 PMC Software Inc. Flemington NJ  
www.pmcsoftware.com



Base	Required
Left	Less Than Right
Right	Required
Top	Less Than Base
S1	
S2	
Edgework	Yes <a href="#">Click to view details.</a>



# SHAPE CATALOG

Copyright 1986 PMC Software Inc. Flemington NJ  
www.pmcsoftware.com

P M C  
**SOFTWARE**

Base	Required
Left	Required
Right	Less Than Left
Top	
S1	
S2	
Edgework	Yes <a href="#">Click to view details.</a>

Copyright 1986 PMC Software Inc. Flemington NJ  
www.pmcsoftware.com

P M C  
**SOFTWARE**

Base	Required
Left	Less Than Right
Right	Required
Top	
S1	
S2	
Edgework	Yes <a href="#">Click to view details.</a>

# SHAPE CATALOG

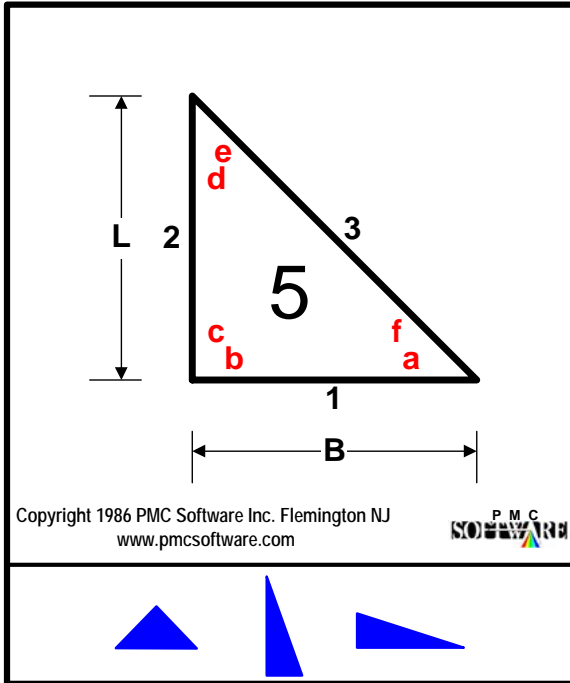

Copyright 1986 PMC Software Inc. Flemington NJ  
www.pmcsoftware.com

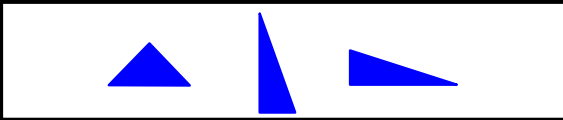

Base	Required
Left	Required Height
Right	
Top	
S1	
S2	
Edgework	Yes <a href="#">Click to view details.</a>

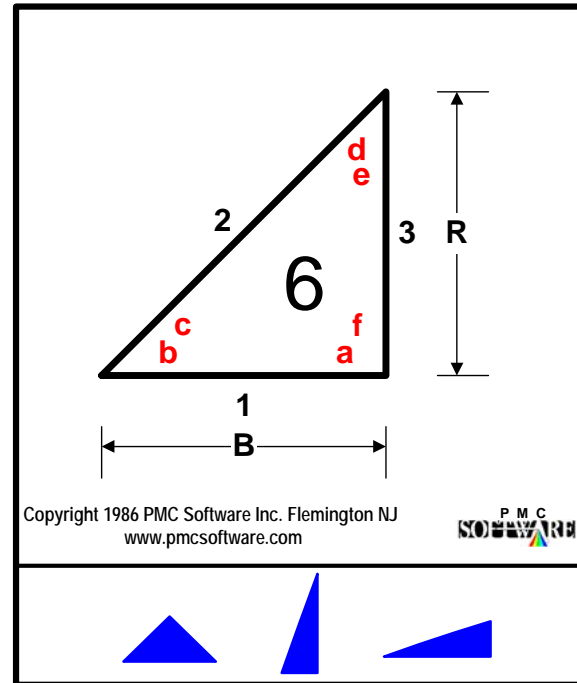

Copyright 1986 PMC Software Inc. Flemington NJ  
www.pmcsoftware.com

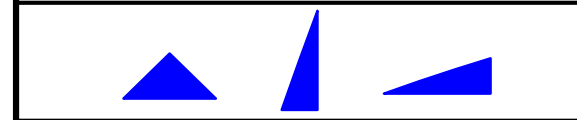

Base	Required
Left	
Right	Required Height
Top	
S1	
S2	
Edgework	Yes <a href="#">Click to view details.</a>



# SHAPE CATALOG

Copyright 1986 PMC Software Inc. Flemington NJ  
www.pmcsoftware.com

Four blue triangles of varying shapes and sizes are shown below the diagram.

Base	Required
Left	Required Height
Right	
Top	
S1	
S2	
Edgework	Yes <a href="#">Click to view details.</a>

Copyright 1986 PMC Software Inc. Flemington NJ  
www.pmcsoftware.com

Four blue triangles of varying shapes and sizes are shown below the diagram.

Base	Required
Left	Required Height
Right	
Top	Less Than Base
S1	
S2	
Edgework	Yes <a href="#">Click to view details.</a>

# SHAPE CATALOG

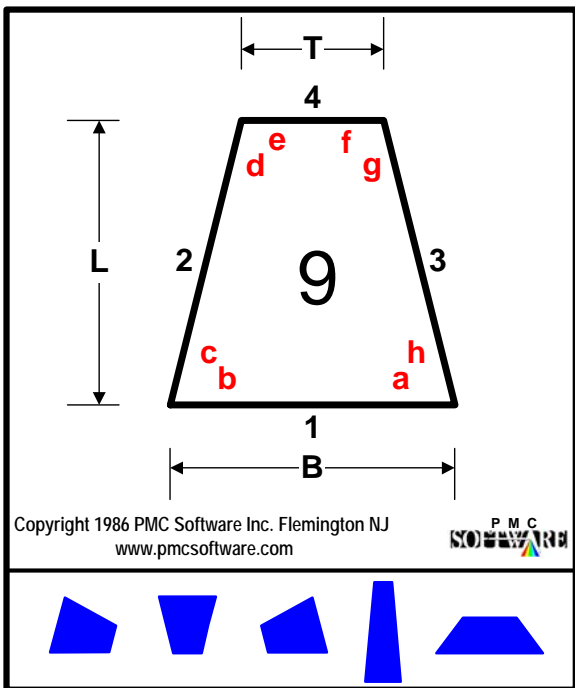

Copyright 1986 PMC Software Inc. Flemington NJ  
www.pmcsoftware.com

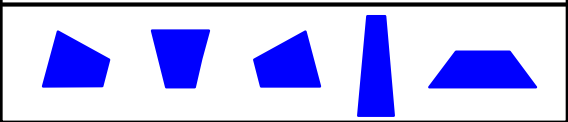

Base	Required
Left	Required Height
Right	
Top	Less Than Base
S1	
S2	
Edgework	Yes <a href="#">Click to view details.</a>

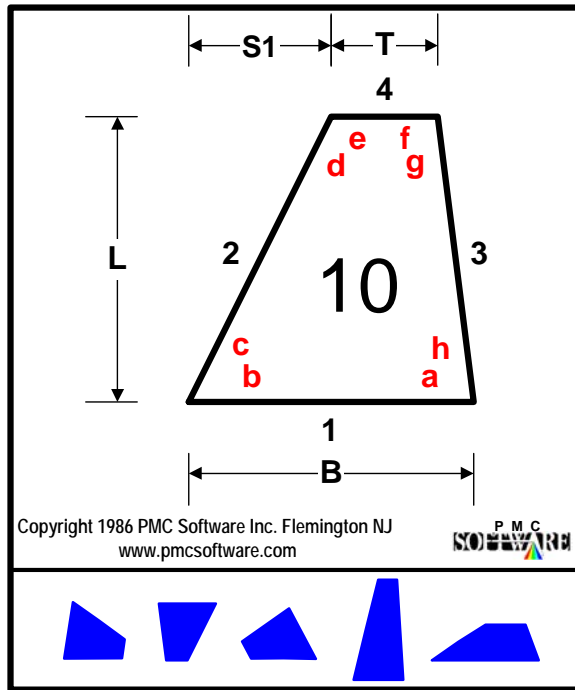

Copyright 1986 PMC Software Inc. Flemington NJ  
www.pmcsoftware.com

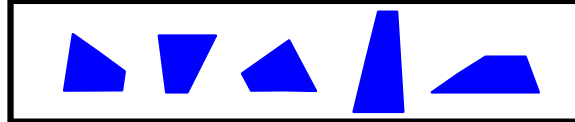

Base	Greater Than S1+Top
Left	Required Height
Right	
Top	Less Than Base
S1	Less Than Base
S2	
Edgework	Yes <a href="#">Click to view details.</a>



# SHAPE CATALOG

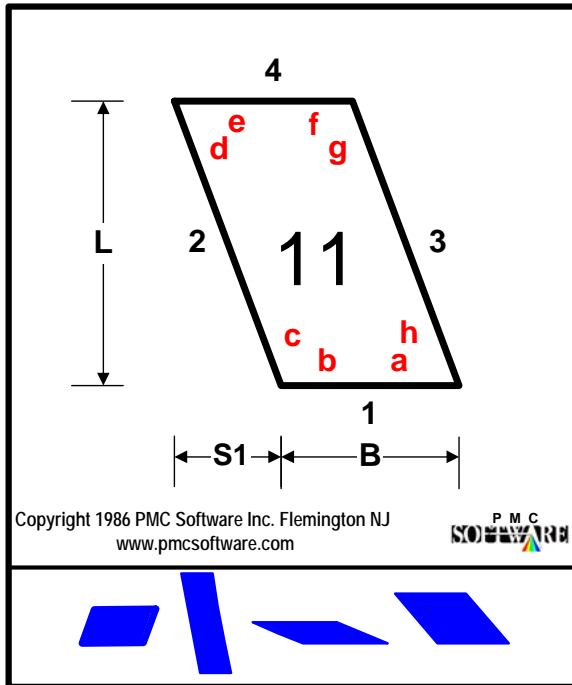

Base	Required
Left	Required Height
Right	
Top	
S1	Required Offset
S2	
Edgework	Yes <a href="#">Click to view details.</a>

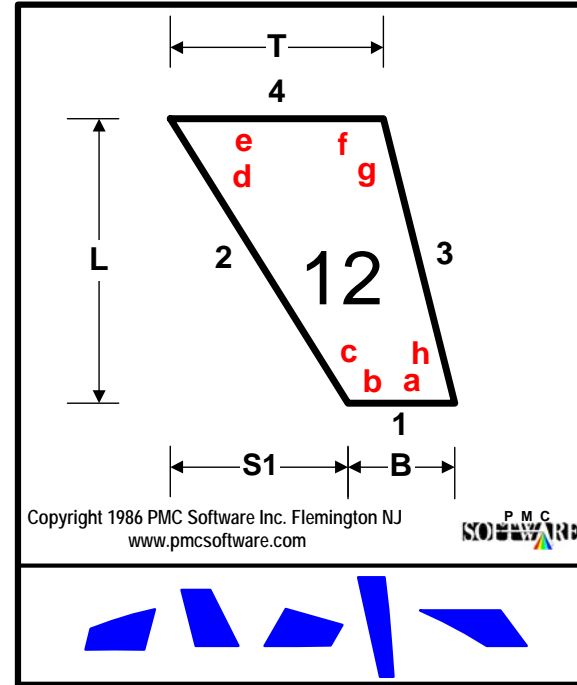

Base	Required
Left	Required Height
Right	
Top	Less Than Base + S1
S1	Required Offset
S2	
Edgework	Yes <a href="#">Click to view details.</a>

# SHAPE CATALOG

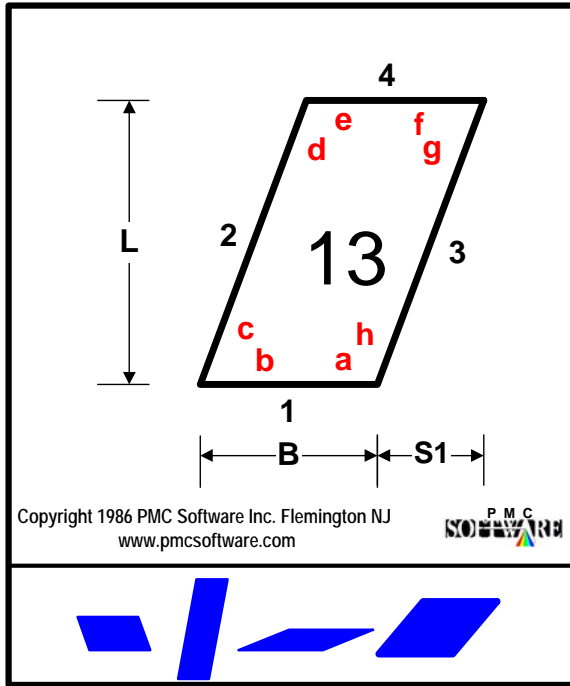

Base	Required
Left	Required Height
Right	
Top	
S1	Required Offset
S2	
Edgework	Yes <a href="#">Click to view details.</a>

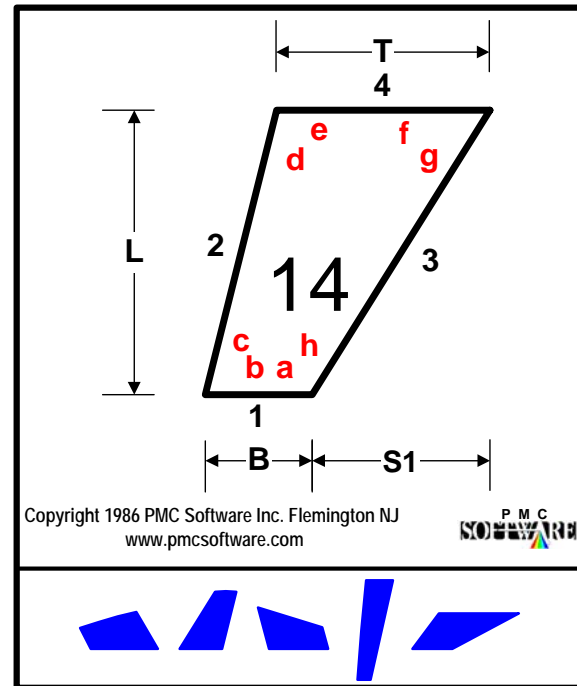

Base	Required
Left	Required Height
Right	
Top	Less Than Base + S1
S1	Required Offset
S2	
Edgework	Yes <a href="#">Click to view details.</a>



# SHAPE CATALOG

Copyright 1986 PMC Software Inc. Flemington NJ  
www.pmcsoftware.com

Base	Required
Left	Required Height
Right	Less Than Left
Top	
S1	
S2	
Edgework	Yes <a href="#">Click to view details.</a>

Copyright 1986 PMC Software Inc. Flemington NJ  
www.pmcsoftware.com

Base	Required
Left	Required Height
Right	Less Than Left
Top	Less Than Base
S1	
S2	
Edgework	No



# SHAPE CATALOG

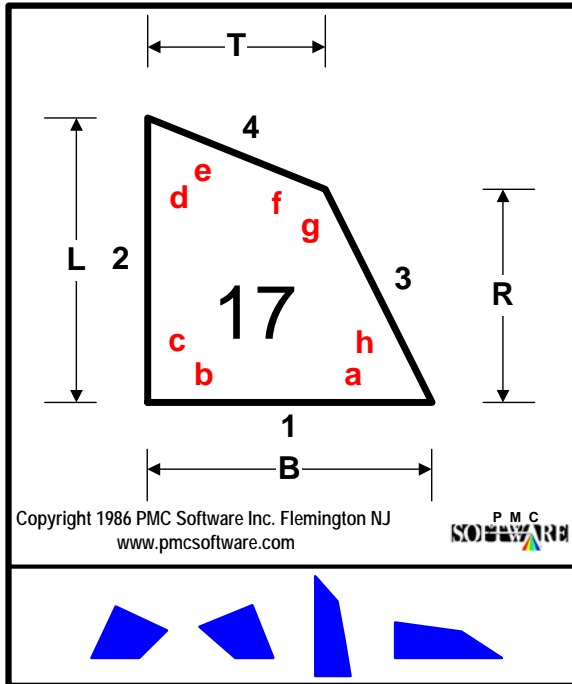

Copyright 1986 PMC Software Inc. Flemington NJ  
www.pmcsoftware.com

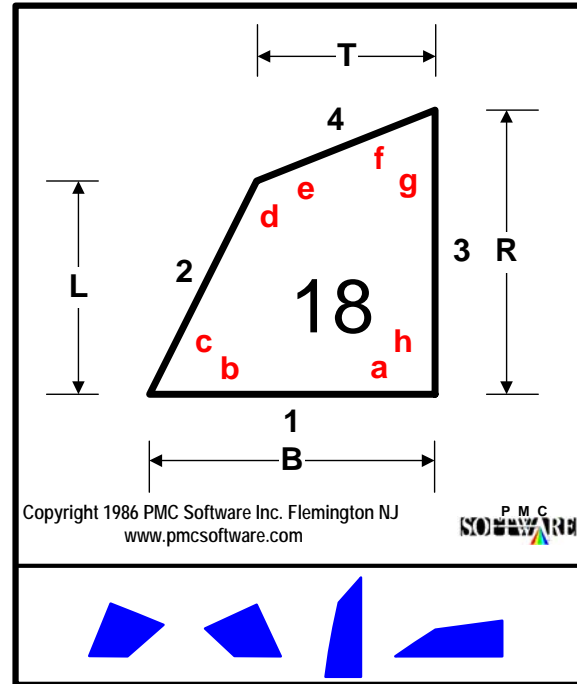

Copyright 1986 PMC Software Inc. Flemington NJ  
www.pmcsoftware.com



Base	Required
Left	Required Height
Right	Less Than Left
Top	Less Than Base
S1	
S2	
Edgework	Yes <a href="#">Click to view details.</a>

Base	Required
Left	Less Than Right
Right	Required Height
Top	Less Than Base
S1	
S2	
Edgework	Yes <a href="#">Click to view details.</a>



# SHAPE CATALOG

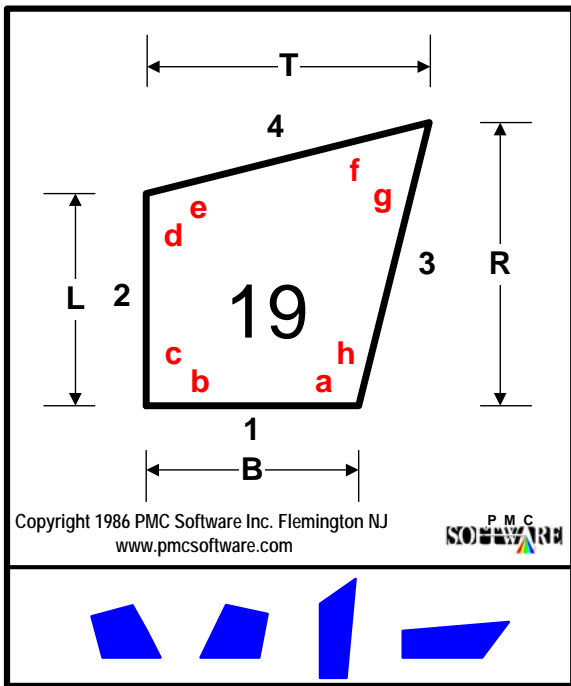

Base	Required
Left	Less Than Right
Right	Required Height
Top	Greater Than Base
S1	
S2	
Edgework	Yes <a href="#">Click to view details.</a>

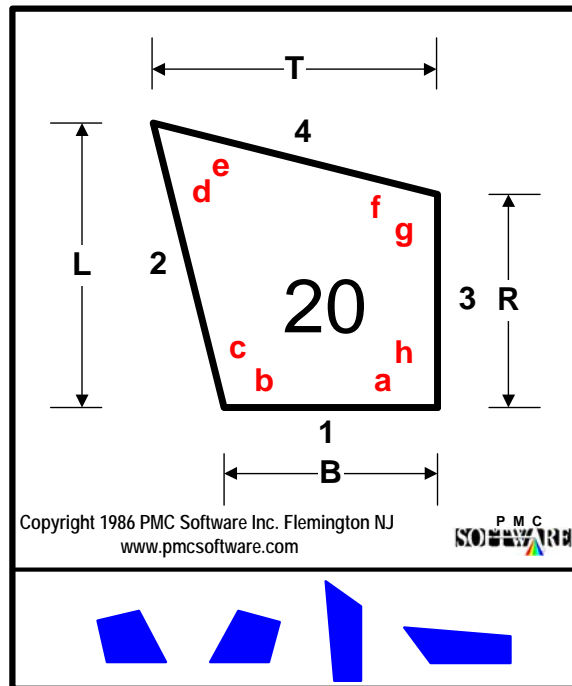

Base	Required
Left	Required Height
Right	Less Than Left
Top	Greater Than Base
S1	
S2	
Edgework	Yes <a href="#">Click to view details.</a>

# SHAPE CATALOG

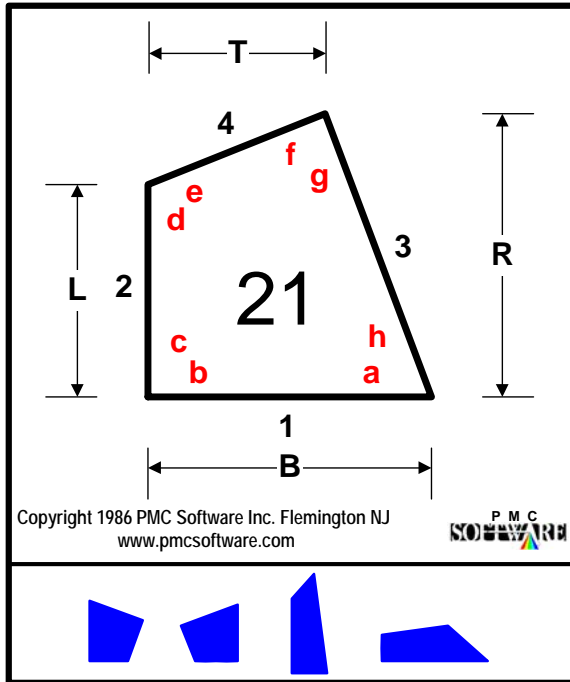

Copyright 1986 PMC Software Inc. Flemington NJ  
www.pmcsoftware.com

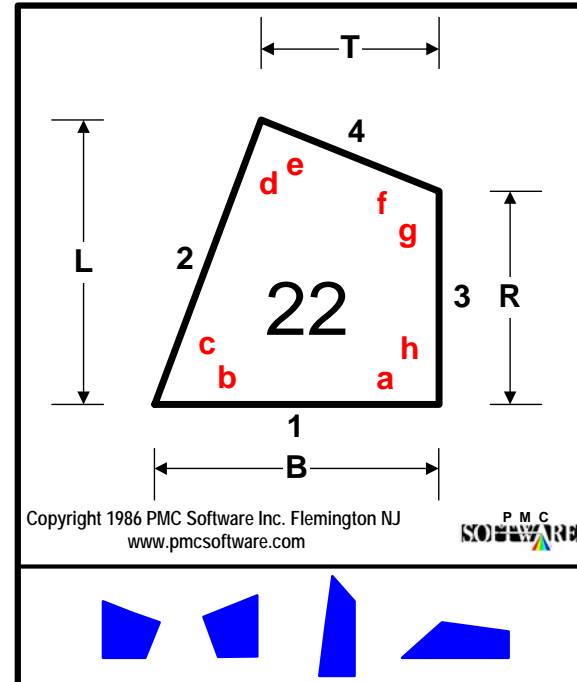

Copyright 1986 PMC Software Inc. Flemington NJ  
www.pmcsoftware.com



Base	Required
Left	Less Than Right
Right	Required Height
Top	Less Than Base
S1	
S2	
Edgework	Yes <a href="#">Click to view details.</a>

Base	Required
Left	Required Height
Right	Less Than Left
Top	Less Than Base
S1	
S2	
Edgework	Yes <a href="#">Click to view details.</a>



# SHAPE CATALOG

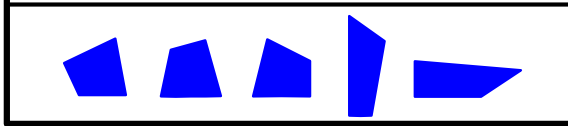
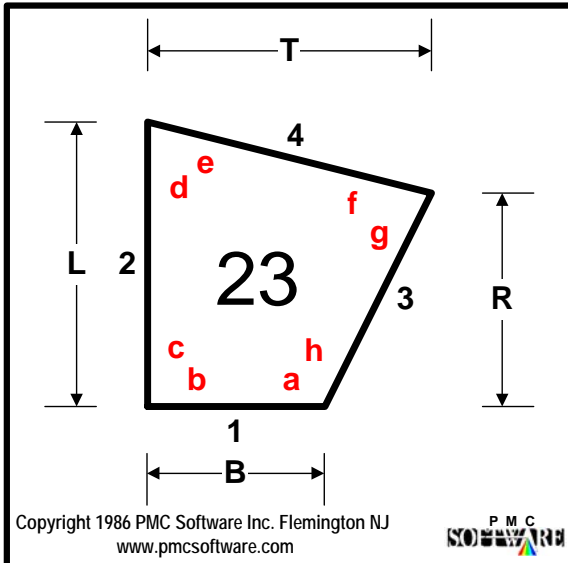

Base	Required
Left	Required Height
Right	Less Than Left
Top	Greater Than Base
S1	
S2	
Edgework	Yes <a href="#">Click to view details.</a>

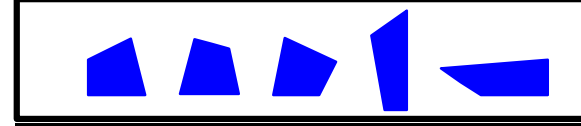
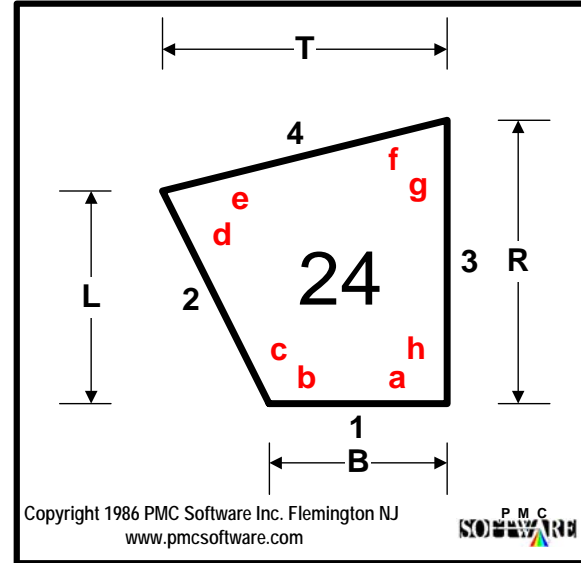

Base	Required
Left	Less Than Right
Right	Required Height
Top	Greater Than Base
S1	
S2	
Edgework	Yes <a href="#">Click to view details.</a>

# SHAPE CATALOG

Diagram of shape 25, an octagon. Dimensions include  $L$  (left height),  $T$  (top width),  $B$  (base width), and  $R$  (right height). The number 25 is centered, with letters a through j arranged around it. The top and bottom edges are labeled with '1', and the left and right edges with '3'. The number 2 is placed near the left and right vertical edges.

Copyright 1986 PMC Software Inc. Flemington NJ  
www.pmcsoftware.com

Base	Required
Left	Required Height
Right	Less Than Left
Top	Less Than Base
S1	
S2	
Edgework	Yes <a href="#">Click to view details.</a>

Diagram of shape 26, a hexagon. Dimensions include  $L$  (left height),  $T$  (top width), and  $B$  (base width). The number 26 is centered, with letters a through j arranged around it. The top and bottom edges are labeled with '1', and the left and right edges with '3'. The number 2 is placed near the left and right vertical edges.

Copyright 1986 PMC Software Inc. Flemington NJ  
www.pmcsoftware.com

Base	Required
Left	Required Height
Right	
Top	Less Than Base
S1	
S2	
Edgework	No



# SHAPE CATALOG

Copyright 1986 PMC Software Inc. Flemington NJ  
www.pmcsoftware.com

Base	Greater than Top+S1
Left	Required Height
Right	Greater or Equal to S2
Top	Less Than Base
S1	Less Than Base
S2	Less Than Right
Edgework	No

Copyright 1986 PMC Software Inc. Flemington NJ  
www.pmcsoftware.com

Base	Greater than Top+S1
Left	Greater or Equal to S2
Right	Required Height
Top	Less Than Base
S1	Less Than Base
S2	Less Than Left
Edgework	No

# SHAPE CATALOG

Copyright 1986 PMC Software Inc. Flemington NJ  
www.pmcsoftware.com

P M C  
**SOFTWARE**

Base	Greater than Top+S1
Left	Less Than Right
Right	Required Height
Top	Less Than Base
S1	Less Than Base
S2	
Edgework	No

Copyright 1986 PMC Software Inc. Flemington NJ  
www.pmcsoftware.com

P M C  
**SOFTWARE**

Base	Greater than Top+S1
Left	Required Height
Right	Less Than Left
Top	Less Than Base
S1	Less Than Base
S2	
Edgework	No



# SHAPE CATALOG

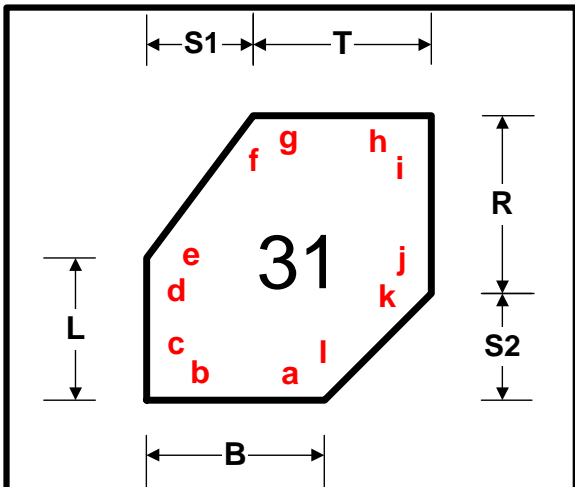

Copyright 1986 PMC Software Inc. Flemington NJ  
www.pmcsoftware.com

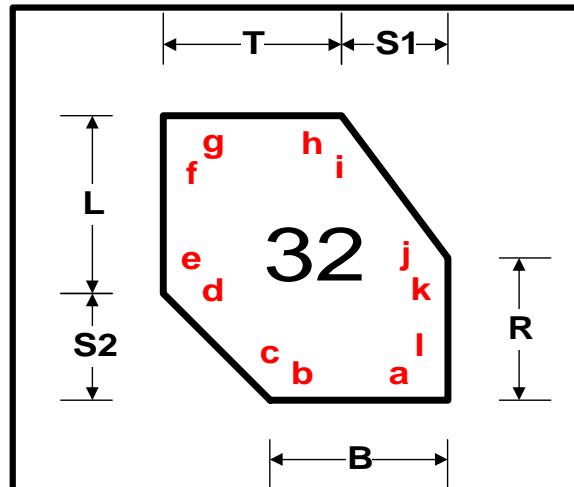

Copyright 1986 PMC Software Inc. Flemington NJ  
www.pmcsoftware.com

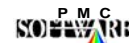

Base	Less Than Top+S1
Left	Less Than Right+S2
Right	Required Height
Top	Required
S1	Required
S2	Required
Edgework	No

Base	Less Than Top+S1
Left	Required
Right	Less Than Left+S2
Top	Required
S1	Required
S2	Required
Edgework	No





# SHAPE CATALOG

Copyright 1986 PMC Software Inc. Flemington NJ  
www.pmcsoftware.com

**PMC SOFTWARE**

Base	Greater than $S1+S2$
Left	Required Height
Right	Less Than Left
Top	
S1	Required
S2	Required
Edgework	No

Copyright 1986 PMC Software Inc. Flemington NJ  
www.pmcsoftware.com

**PMC SOFTWARE**

Base	Greater than $S1+S2$
Left	Less Than Right
Right	Required Height
Top	
S1	Required
S2	Required
Edgework	No



# SHAPE CATALOG

Copyright 1986 PMC Software Inc. Flemington NJ  
www.pmcsoftware.com

Base	Required
Left	Less Than Right
Right	Required Height
Top	Less Than S1+Base
S1	Required Offset
S2	
Edgework	No

Copyright 1986 PMC Software Inc. Flemington NJ  
www.pmcsoftware.com

Base	Required
Left	Required Height
Right	Less Than Left
Top	Less Than S1+Base
S1	Required Offset
S2	
Edgework	No

# SHAPE CATALOG

Copyright 1986 PMC Software Inc. Flemington NJ  
www.pmcsoftware.com

Base	Required Width
Left	Required Height
Right	Less Than Left
Top	Less Than Base
S1	Less Than Base
S2	
Edgework	No

Copyright 1986 PMC Software Inc. Flemington NJ  
www.pmcsoftware.com

Base	Required
Left	Required Height
Right	Less Than Left
Top	Less Than Base
S1	
S2	
Edgework	No



# SHAPE CATALOG

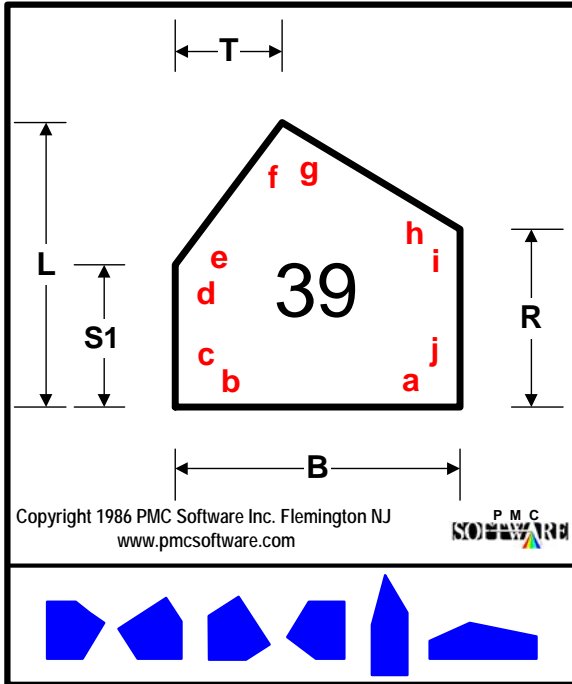

Base	Required
Left	Required Height
Right	Less Than Left
Top	Less Than Base
S1	Less Than Right
S2	
Edgework	No

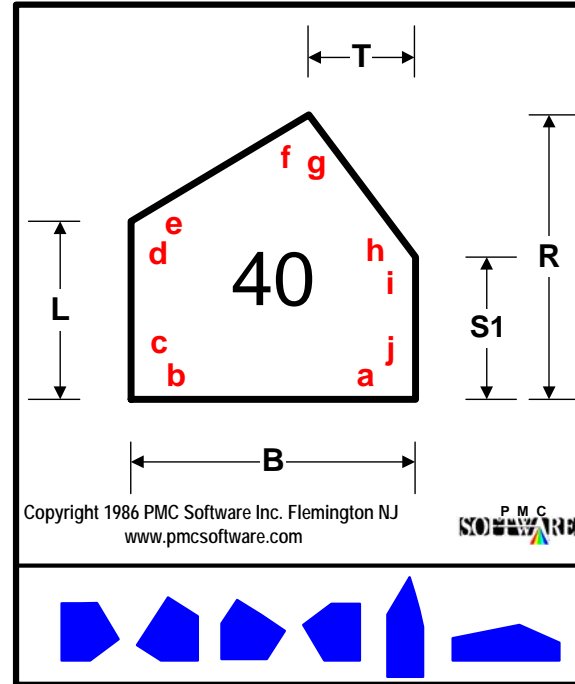

Base	Required
Left	Less Than Right
Right	Required Height
Top	Less Than Base
S1	Less Than Left
S2	
Edgework	No

ARC  
SHAPES

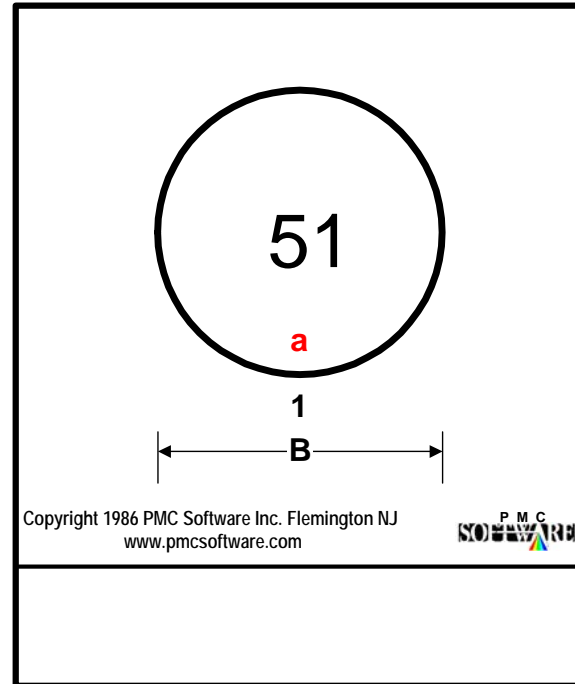

Base	Required Diameter
Left	
Right	
Top	
S1	
S2	
Edgework	Yes <a href="#">Click to view details.</a>

# SHAPE CATALOG

52

B

Copyright 1986 PMC Software Inc. Flemington NJ  
www.pmcsoftware.com

Base	Required Diameter
Left	
Right	
Top	
S1	
S2	
Edgework	No

53

B

Copyright 1986 PMC Software Inc. Flemington NJ  
www.pmcsoftware.com

Base	Required Radius
Left	
Right	
Top	
S1	
S2	
Edgework	Yes <a href="#">Click to view details.</a>

# SHAPE CATALOG

Copyright 1986 PMC Software Inc. Flemington NJ  
www.pmcsoftware.com

P M C  
**SOFTWARE**

Base	Required
Left	Required Height
Right	Less Than Left
Top	Less Than Base
<b>Note</b>	<b>Left - Right = Base - Top</b>
Edgework	Yes <a href="#">Click to view details.</a>

Copyright 1986 PMC Software Inc. Flemington NJ  
www.pmcsoftware.com

P M C  
**SOFTWARE**

Base	Required
Left	Less Than Right
Right	Required Height
Top	Less Than Base
<b>Note</b>	<b>Right - Left = Base - Top</b>
Edgework	Yes <a href="#">Click to view details.</a>



# SHAPE CATALOG

Copyright 1986 PMC Software Inc. Flemington NJ  
www.pmcsoftware.com

Base	Required
Left	Greater Than S1
Right	
Top	
S1	2 Times S1 Less Than Base
S2	
Edgework	Yes <a href="#">Click to view details.</a>

Copyright 1986 PMC Software Inc. Flemington NJ  
www.pmcsoftware.com

Base	Required
Left	Greater than 2 Times S1
Right	
Top	
S1	2 Times S1 Less Than Base
S2	
Edgework	Yes <a href="#">Click to view details.</a>



# SHAPE CATALOG

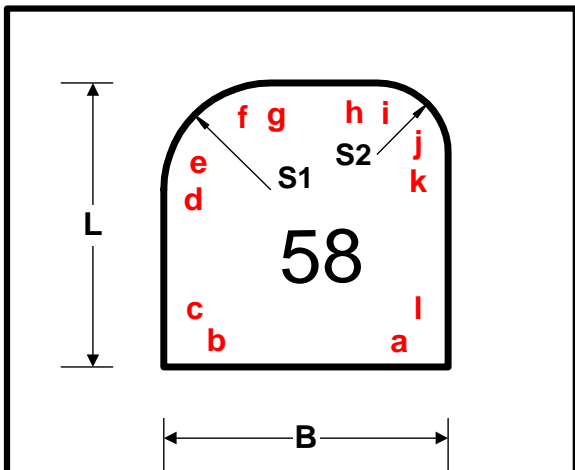

Copyright 1986 PMC Software Inc. Flemington NJ  
www.pmcsoftware.com

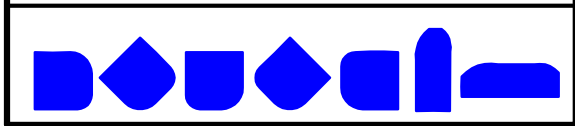

Base	Greater than S1+S2
Left	Required Height
Right	
Top	
S1	Less Than Left
S2	Less Than Left
Edgework	No

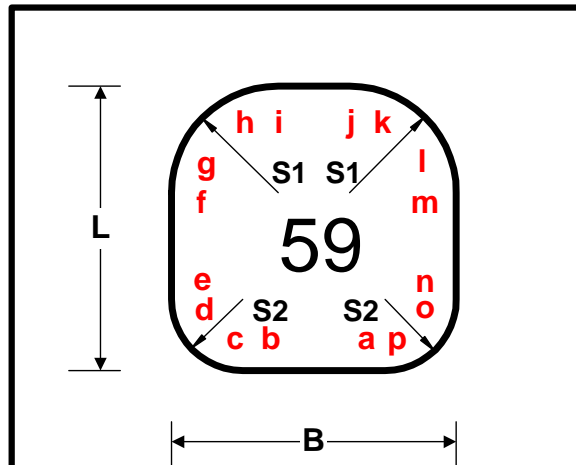

Copyright 1986 PMC Software Inc. Flemington NJ  
www.pmcsoftware.com

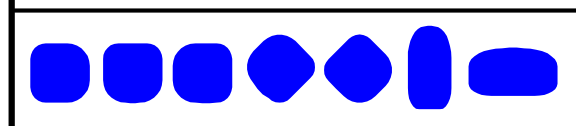

Base	Required
Left	Greater than S1+S2
Right	
Top	
S1	2 Times S1 Less Than Base
S2	2 Times S2 Less Than Base
Edgework	No



# SHAPE CATALOG

Copyright 1986 PMC Software Inc. Flemington NJ  
www.pmcsoftware.com

Base	Less Than 2 Times S1
Left	Required
Right	
Top	
S1	Required
S2	
Edgework	No

Copyright 1986 PMC Software Inc. Flemington NJ  
www.pmcsoftware.com

Base	Less Than 2 Times Right
Left	
Right	Greater Than Top
Top	Less Than 1/2 Base
S1	
S2	
Edgework	No

# SHAPE CATALOG

Copyright 1986 PMC Software Inc. Flemington NJ  
www.pmcsoftware.com

**P M C**  
**SOFTWARE**

Base	Required
Left	Required Height
Right	
Top	
S1	2 Times S1 Greater Than or Equal to Base
S2	2 Times S2 Greater Than or Equal to Base
Edgework	No

Copyright 1986 PMC Software Inc. Flemington NJ  
www.pmcsoftware.com

**P M C**  
**SOFTWARE**

Base	
Left	Greater than 1/2 Base
Right	
Top	
S1	
S2	
Edgework	No



# SHAPE CATALOG

64

Copyright 1986 PMC Software Inc. Flemington NJ  
www.pmcsoftware.com

Base	Less than Right
Left	
Right	Required
Top	
S1	
S2	
Edgework	No

65

Copyright 1986 PMC Software Inc. Flemington NJ  
www.pmcsoftware.com

Base	Greater Than Top
Left	
Right	Greater Than Base
Top	Less Than Right
S1	Optional
S2	
Edgework	No

# SHAPE CATALOG

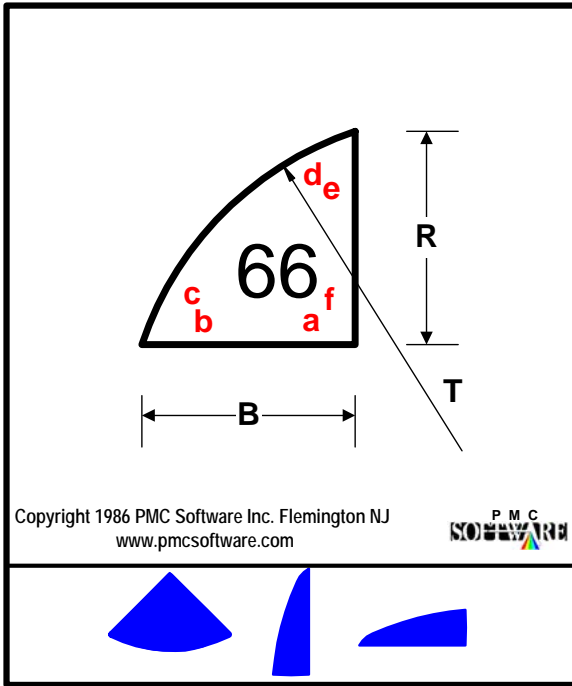

Copyright 1986 PMC Software Inc. Flemington NJ  
www.pmcsoftware.com



Base	Less Than Top
Left	
Right	Less Than Top
Top	Radius Of Arch
S1	
S2	
Edgework	No

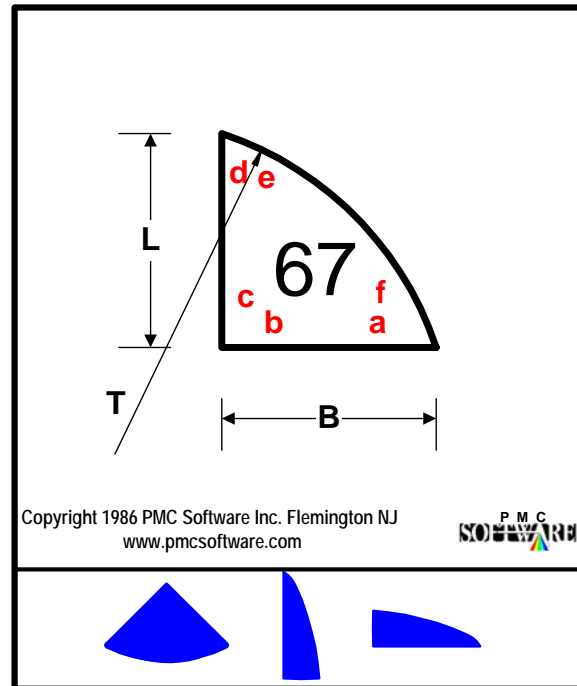

Copyright 1986 PMC Software Inc. Flemington NJ  
www.pmcsoftware.com



Base	Less Than Top
Left	Less Than Top
Right	
Top	Radius Of Arch
S1	
S2	
Edgework	No



# SHAPE CATALOG

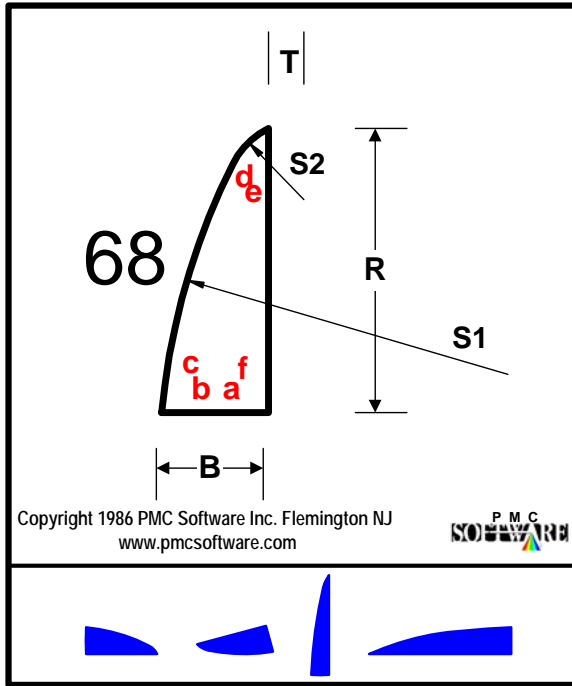

Base	Less Than S1
Left	
Right	Greater than S2, Less Than S1
Top	Required
S1	Radius of Arch, Greater Than S2
S2	Radius of Top Arch
Edgework	No

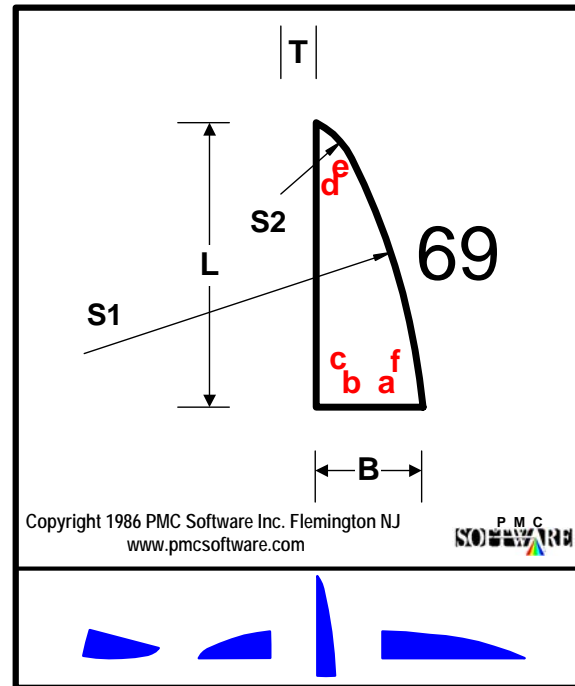

Base	Less Than S1
Left	Greater Than S2, Less Than S1
Right	
Top	Required
S1	Radius Of Arch, Greater Than S2
S2	Radius Of Top Arch
Edgework	No

# SHAPE CATALOG

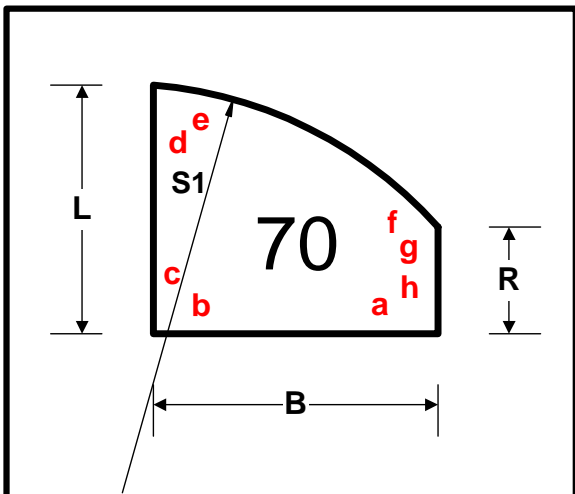

Copyright 1986 PMC Software Inc. Flemington NJ  
www.pmcsoftware.com

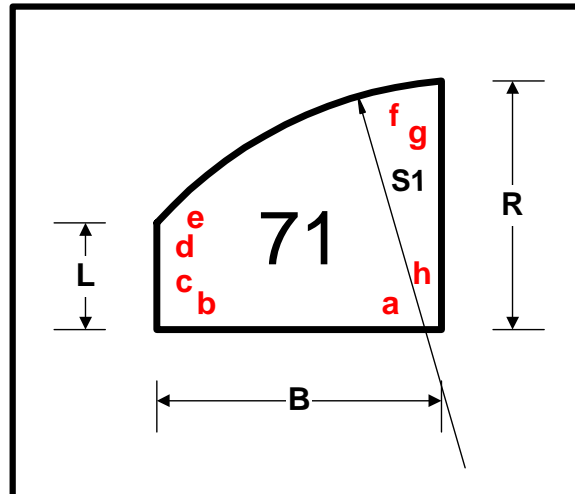

Copyright 1986 PMC Software Inc. Flemington NJ  
www.pmcsoftware.com



Base	Required
Left	Required
Right	Less Than Left
Top	
S1	Greater or Equal to Base
S2	
Edgework	No



Base	Required
Left	Less Than Right
Right	Required
Top	
S1	Greater Or Equal To Base
S2	
Edgework	No



# SHAPE CATALOG

Copyright 1986 PMC Software Inc. Flemington NJ  
www.pmcsoftware.com

PMC SOFTWARE

Base	Required
Left	Required
Right	Less Than Left
Top	
S1	Greater Or Equal to 1/2 Base
S2	
Edgework	No

Copyright 1986 PMC Software Inc. Flemington NJ  
www.pmcsoftware.com

PMC SOFTWARE

Base	Required
Left	Required
Right	
Top	
S1	Greater or Equal to Base
S2	
Edgework	No



# SHAPE CATALOG

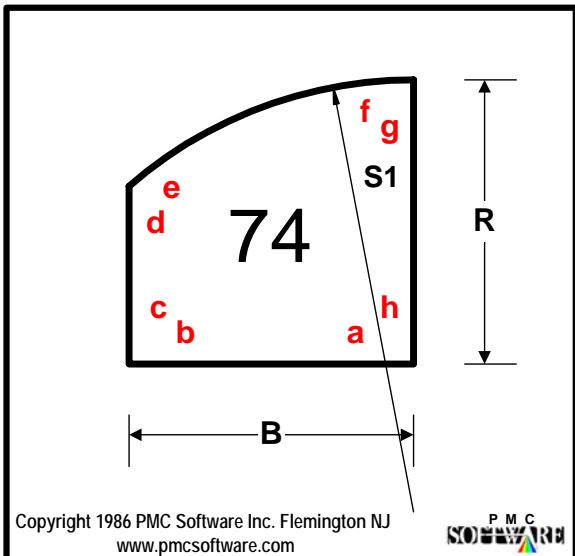

Base	Required
Left	
Right	Required
Top	
S1	Greater or Equal To Base
S2	
Edgework	No

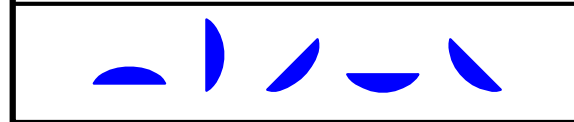
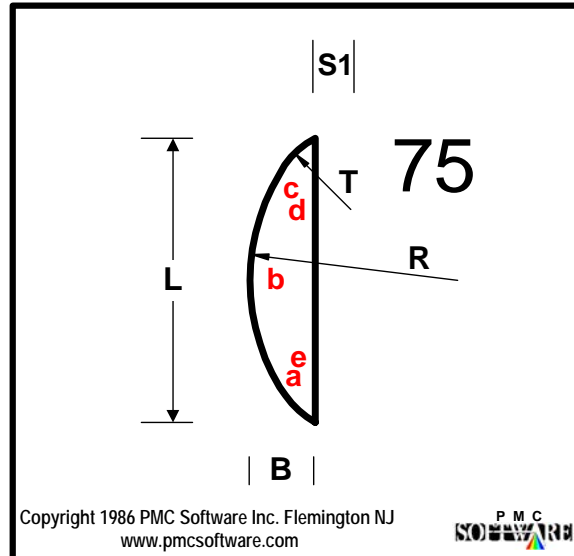

Base	Required
Left	Greater Than Top
Right	Greater Than Base
Top	Less Than Left
S1	Required
S2	
Edgework	No



# SHAPE CATALOG

**79**

Copyright 1986 PMC Software Inc. Flemington NJ  
www.pmcsoftware.com

**Orthographic View**  
**Double - Outboard Larger than Inboard**  
**Triple - Outboard Larger than Middle and Inboard**  
**All Views are Outside looking In**

Base	Required
Left	Required
Right	
Top	Less Than Left
Edgework	No

**80**

Copyright 1986 PMC Software Inc. Flemington NJ  
www.pmcsoftware.com

**Orthographic View**  
**Double - Outboard Larger than Inboard**  
**Triple - Outboard Larger than Middle and Inboard**  
**All Views are Outside looking In**

Base	Required
Left	Required
Right	Less Than Left
Top	
Edgework	No

# SHAPE CATALOG

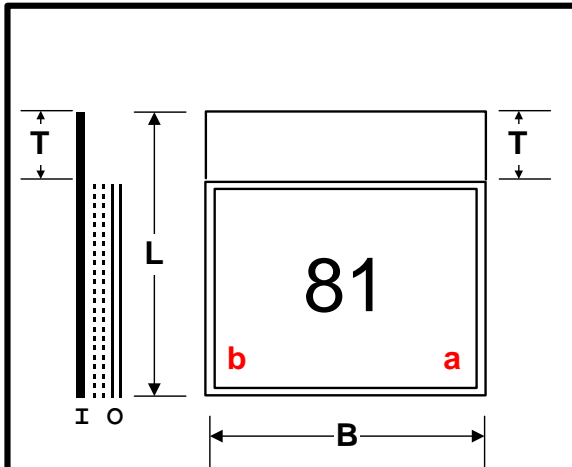

Copyright 1986 PMC Software Inc. Flemington NJ  
www.pmcsoftware.com



**Orthographic View**  
**Double - Inboard Larger than Outboard**  
**Triple - Inboard Larger than Middle and Outboard**  
**All Views are Outside looking In**

Base	Required
Left	Required
Right	
Top	Less Than Left
Edgework	No

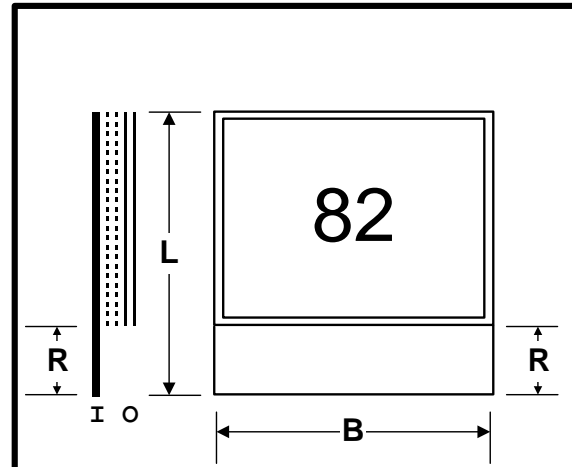

Copyright 1986 PMC Software Inc. Flemington NJ  
www.pmcsoftware.com



**Orthographic View**  
**Double - Inboard Larger than Outboard**  
**Triple - Inboard Larger than Middle and Outboard**  
**All Views are Outside looking In**

Base	Required
Left	Required
Right	Less Than Left
Top	
Edgework	No



# SHAPE CATALOG

**83**

Copyright 1986 PMC Software Inc. Flemington NJ  
www.pmcsoftware.com

**PMC SOFTWARE**

*Orthographic View*  
**Double - Outboard Larger than Inboard**  
**Triple - Outboard Larger than Middle and Inboard**  
**All Views are Outside looking In**

Base	Required
Left	Required
Right	Less Than Base
Top	
Edgework	No

**84**

Copyright 1986 PMC Software Inc. Flemington NJ  
www.pmcsoftware.com

**PMC SOFTWARE**

*Orthographic View*  
**Double - Outboard Larger than Inboard**  
**Triple - Outboard Larger than Middle and Inboard**  
**All Views are Outside looking In**

Base	Required
Left	Required
Right	
Top	Less Than Base
Edgework	No

# SHAPE CATALOG

**85**

Copyright 1986 PMC Software Inc. Flemington NJ  
www.pmcsoftware.com

**Orthographic View**  
**Double - Inboard Larger than Outboard**  
**Triple - Inboard Larger than Middle and Outboard**  
**All Views are Outside looking In**

Base	Required
Left	Required
Right	Less Than Base
Top	
Edgework	No

**86**

Copyright 1986 PMC Software Inc. Flemington NJ  
www.pmcsoftware.com

**Orthographic View**  
**Double - Inboard Larger than Outboard**  
**Triple - Inboard Larger than Middle and Outboard**  
**All Views are Outside looking In**

Base	Required
Left	Required
Right	
Top	Less Than Base
Edgework	No



# SHAPE CATALOG

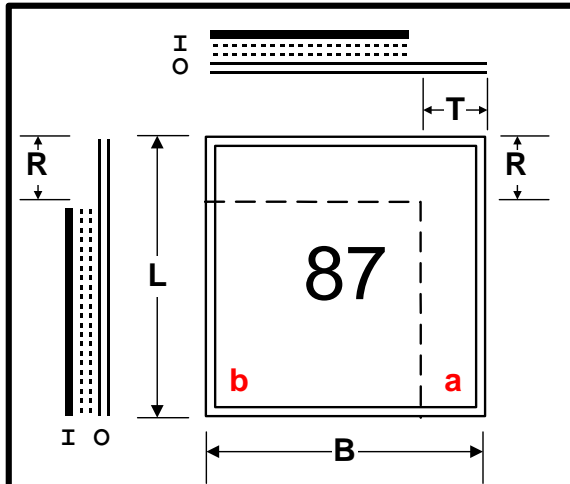

Copyright 1986 PMC Software Inc. Flemington NJ  
www.pmcsoftware.com



**Orthographic View**  
**Double - Outboard Larger than Inboard**  
**Triple - Outboard Larger than Middle and Inboard**  
**All Views are Outside looking In**

Base	Required
Left	Required
Right	Less Than Left
Top	Less Than Base
Edgework	No

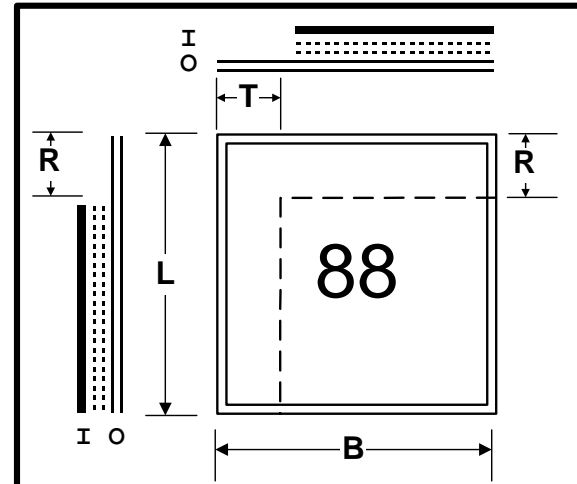

Copyright 1986 PMC Software Inc. Flemington NJ  
www.pmcsoftware.com



**Orthographic View**  
**Double - Outboard Larger than Inboard**  
**Triple - Outboard Larger than Middle and Inboard**  
**All Views are Outside looking In**

Base	Required
Left	Required
Right	Less Than Left
Top	Less Than Base
Edgework	No



# SHAPE CATALOG

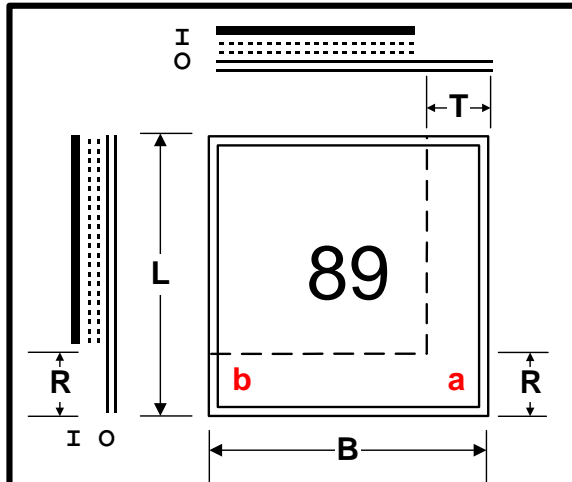

Copyright 1986 PMC Software Inc. Flemington NJ  
www.pmcsoftware.com



**Orthographic View**  
**Double - Outboard Larger than Inboard**  
**Triple - Outboard Larger than Middle and Inboard**  
**All Views are Outside looking In**

Base	Required
Left	Required
Right	Less Than Left
Top	Less Than Base
Edgework	No

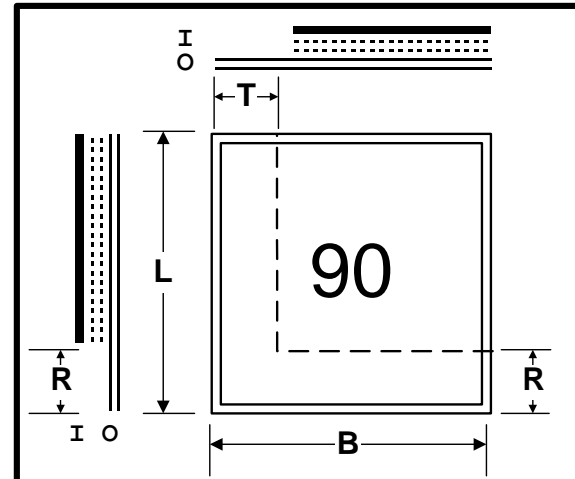

Copyright 1986 PMC Software Inc. Flemington NJ  
www.pmcsoftware.com



**Orthographic View**  
**Double - Outboard Larger than Inboard**  
**Triple - Outboard Larger than Middle and Inboard**  
**All Views are Outside looking In**

Base	Required
Left	Required
Right	Less Than Left
Top	Less Than Base
Edgework	No



# SHAPE CATALOG

Copyright 1986 PMC Software Inc. Flemington NJ  
www.pmcsoftware.com

**Orthographic View**  
**Double - Inboard Larger than Outboard**  
**Triple - Inboard Larger than Middle and Outboard**  
**All Views are Outside looking In**

Base	Required
Left	Required
Right	Less Than Left
Top	Less Than Base
Edgework	No

Copyright 1986 PMC Software Inc. Flemington NJ  
www.pmcsoftware.com

**Orthographic View**  
**Double - Inboard Larger than Outboard**  
**Triple - Inboard Larger than Middle and Outboard**  
**All Views are Outside looking In**

Base	Required
Left	Required
Right	Less Than Left
Top	Less Than Base
Edgework	No



# SHAPE CATALOG

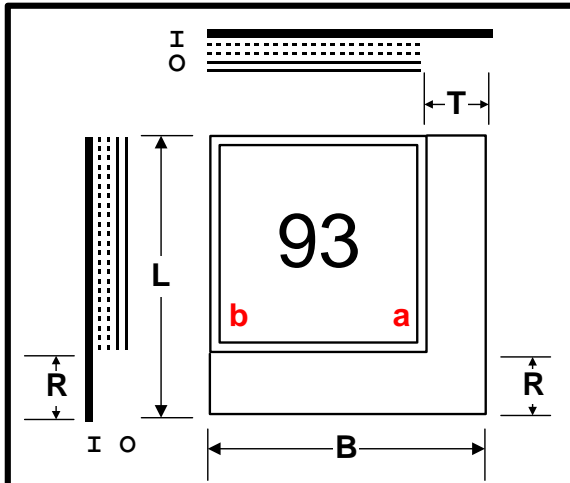

Copyright 1986 PMC Software Inc. Flemington NJ  
www.pmcsoftware.com



**Orthographic View**  
**Double - Inboard Larger than Outboard**  
**Triple - Inboard Larger than Middle and Outboard**  
**All Views are Outside looking In**

Base	Required
Left	Required
Right	Less Than Left
Top	Less Than Base
Edgework	No

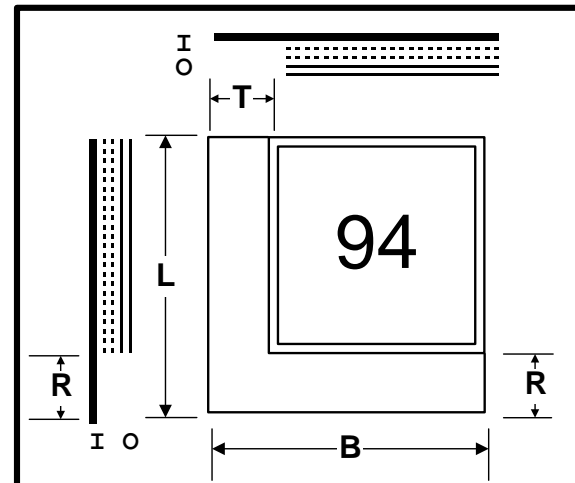

Copyright 1986 PMC Software Inc. Flemington NJ  
www.pmcsoftware.com



**Orthographic View**  
**Double - Inboard Larger than Outboard**  
**Triple - Inboard Larger than Middle and Outboard**  
**All Views are Outside looking In**

Base	Required
Left	Required
Right	Less Than Left
Top	Less Than Base
Edgework	No



# SHAPE CATALOG

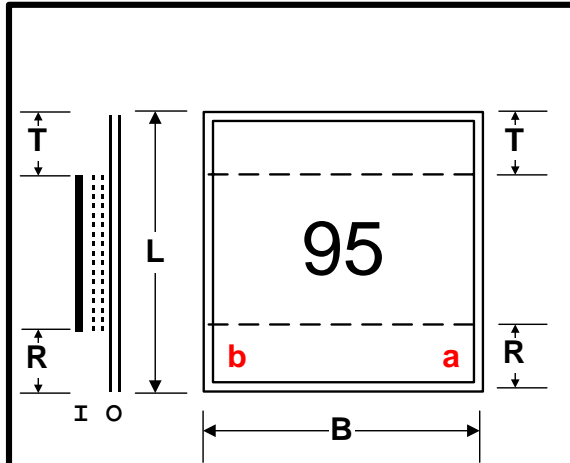

Copyright 1986 PMC Software Inc. Flemington NJ  
www.pmcsoftware.com



**Orthographic View**  
**Double - Outboard Larger than Inboard**  
**Triple - Outboard Larger than Middle and Inboard**  
**All Views are Outside looking In**

Base	Required
Left	Required
Right	Less Than Left
Top	Less Than Left
<b>Note</b>	<b>Left Must Be Greater Than Right + Top</b>
Edgework	No

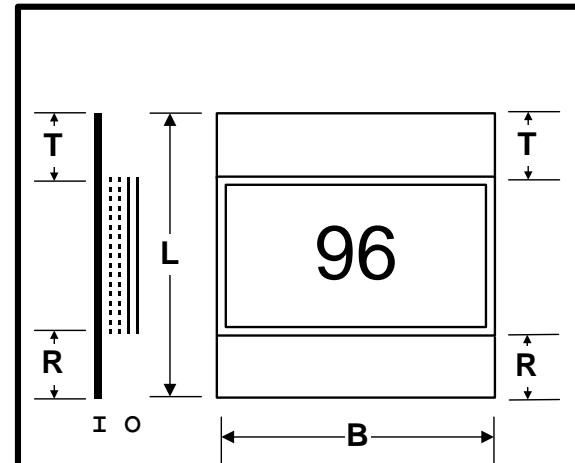

Copyright 1986 PMC Software Inc. Flemington NJ  
www.pmcsoftware.com



**Orthographic View**  
**Double - Inboard Larger than Outboard**  
**Triple - Inboard Larger than Middle and Outboard**  
**All Views are Outside looking In**

Base	Required
Left	Required
Right	Less Than Left
Top	Less Than Left
<b>Note</b>	<b>Left Must Be Greater Than Right + Top</b>
Edgework	No



# SHAPE CATALOG

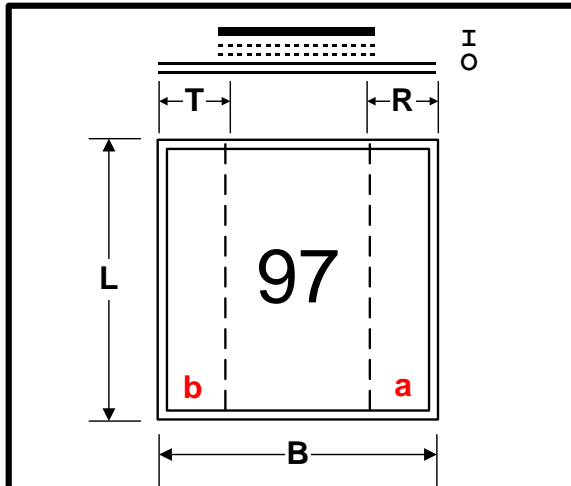

Copyright 1986 PMC Software Inc. Flemington NJ  
www.pmcsoftware.com



**Orthographic View**  
**Double - Outboard Larger than Inboard**  
**Triple - Outboard Larger than Middle and Inboard**  
**All Views are Outside looking In**

Base	Required
Left	Required
Right	Less Than Base
Top	Less Than Base
<b>Note</b>	<b>Base Must Be Greater Than Right + Top</b>
Edgework	No

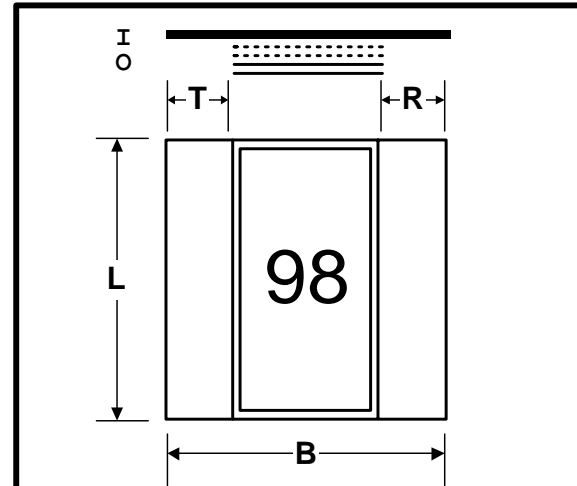

Copyright 1986 PMC Software Inc. Flemington NJ  
www.pmcsoftware.com



**Orthographic View**  
**Double - Inboard Larger than Outboard**  
**Triple - Inboard Larger than Middle and Outboard**  
**All Views are Outside looking In**

Base	Required
Left	Required
Right	Less Than Base
Top	Less Than Base
<b>Note</b>	<b>Base Must Be Greater Than Right + Top</b>
Edgework	No



# SHAPE CATALOG

Click a shape to return to its detail.

## EDGEWORK SIDE DEFINITIONS

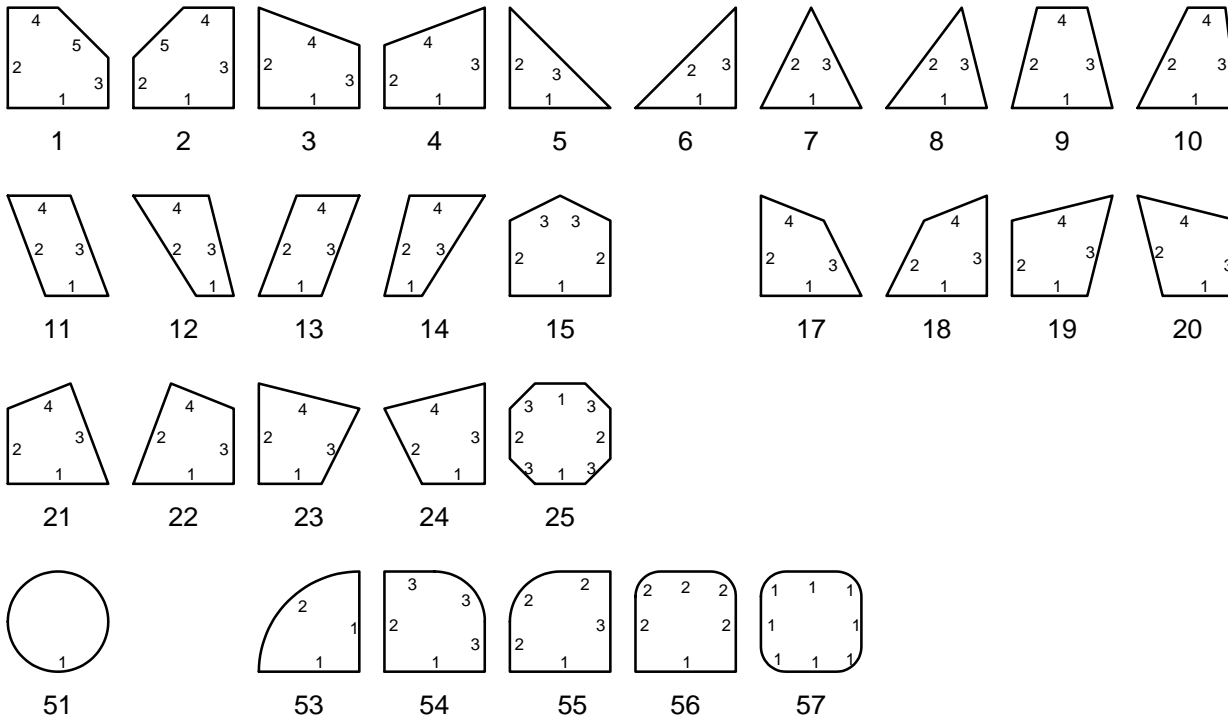

To insure that each edge of the glass gets the type of fabrication you need, please use the “side numbers” when stating your fabrication needs. If you have requirements not shown above, please contact our order desk or your salesperson for more details.